



FITTING INSTRUCTIONS

TAIL GATE LIFT ASSIST KIT TO SUIT HILUX SR5 'A' DECK 4714030



KIT: 6177683

IMPORTANT

- ◆ This product must be installed exactly as per these instructions using only the hardware supplied.
- ◆ Failure to follow the instructions precisely may lead to failure of the product or result in injury.
- ◆ The installation of this product may require the use of specialized tools and/or techniques.
- ◆ During installation, it is the duty of the installer to check correct operation/clearances of all components.
- ◆ Work safely at all times.
- ◆ Specific installation can vary, so please read the following instructions as they refer to important information, which could affect the quality of the final installation.
- ◆ It is advisable to have these parts fitted by an authorised dealer.
- ◆ **Ensuring that the specified torques are used as contained in this fitting instruction is imperative, as failure may occur.**
- ◆ **IF IN DOUBT CONTACT ARB FOR FURTHER INSTRUCTIONS.**

HAVE AVAILABLE THESE SAFETY ITEMS WHEN FITTING PRODUCT:

Protective eyewear		Hearing protection		Gloves	
--------------------	--	--------------------	--	--------	--

NOTE: 'WARNING' notes in the fitting procedure relate to OHS situations, where to avoid a potentially hazardous situation it is suggested that protective safety gear be worn or a safe work procedure be employed. If these notes and warnings are not heeded, injury may result.

CARE INSTRUCTIONS:

In general, the Tailgate Assist system is maintenance free with no need for regular attention. However the following should be noted:-

- ◆ When cleaning, use a non-caustic soap and avoid aiming high pressure water jets into the seal area of the Damper.
- ◆ If grinding noises come from the ball sockets, remove the ball sockets (being careful not to lose or damage the clip) and clean any grit from the ball socket and ball.
- ◆ Avoid excessive heat (greater than 80°C)
- ◆ DO NOT grip piston rod with pliers, vice or similar (avoid scratching, denting or bending the rod).
- ◆ Avoid paint overspray, weld or grinding splatter, or materials such as glue.
- ◆ Avoid cleaning products that leave a coating such as silicones.
- ◆ Avoid applying adhesive tape to the piston rod.

TOOL LIST FOR FITMENT:

<ul style="list-style-type: none">• Torque Wrench• Hex sockets, 12,13 & 17• Socket driver• T40 Torx bit.• Drill• 5mm & 10mm drill bits	<ul style="list-style-type: none">• Allen Key set.(3,4 & 5mm)• Flat screw driver• Ratchet Spanner hexagon 14,19mm.• Open end hexagon spanner 14mm.• Felt tip marking pen (non-permanent)
---	--

FITTING IS UNDERTAKEN IN THE FOLLOWING STEPS:





1. Fitting the Torsion bar components
2. Fitting the Limiting strap components RH
3. Fitting the Limiting strap components LH
4. Fitting Dampener on LH side.





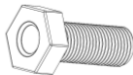
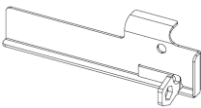

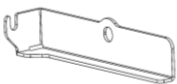





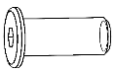
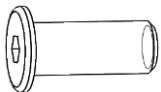

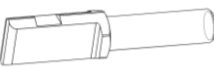

!! IMPORTANT !!



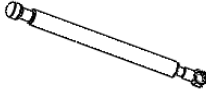







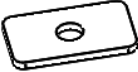

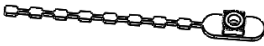
REQUIRED SCREW TORQUES: Refer to steps in fitting instruction

Screw torques must be adhered to. Over torquing can cause failure of components.

THE FITTING KIT CONTAINS:

1. 6177683	Part No	Picture	Qty	Description
	6365071		1	M12 THREADED BUSH
	4654527		1	BRACKET – TORSION BAR TUB MOUNT
	3195116		1	TORSION BAR MOUNT BACK PLATE
	3750386		1	BRACKET – TORSION BAR TAILGATE MOUNT
	6151766		1	NUT – NYLOC M12

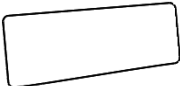
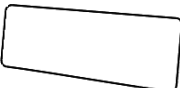
6151547		3	NUT – NYLOC M8
6151322		2	NUT – NYLOC M10
6151882		1	SCREW - M8 x 20 ULTRA THIN
6152031		3	SCREW – M10 x 20 ULTRA THIN
6151464		2	SCREW – M8 x 25 BUTTON HEAD
6151905		1	HEX STUD BOLT – M10 x 35
3193801		2	SUPPORT BLADE
4590030		1	TORSION SPRING
6364515		1	SLEEVE – TORSION BAR
6152030		1	BALL STUD – THREADED M10
6151908		1	BALL STUD – M8 COUNTERSUNK
4590031		1	DAMPER
6602018		1	ALCOHOL WIPE
4584328		7	WASHER – M8 x 19 x 1.2
4581291		4	WASHER M10
5848468		2	SPACER
6151906		1	GRUB SCREW – M6 x 8

3195138		1	BACK PLATE
6821348		2	CABLE – LIMIT STRAP
3759081		2	WELD NUT ASSY
3750441R		1	BRACKET – UPPER MOUNT RH
3750441L		1	BRACKET – UPPER MOUNT LH
3750443R		1	LOWER CABLE MOUNT RH
3750443L		1	LOWER CABLE MOUNT LH
3195150		2	PLATE
3750444R		1	BRACKET – CABLE KEEPER RH
3750444L		1	BRACKET – CABLE KEEPER LH
2125725		2	STICKER – ABRASION RESISTANT
2125739R		1	BLACKOUT PATCH RH
2125739L		1	BLACKOUT PATCH LH
2125755R		1	STRAP SLIP PAD RH
2125755L		1	STRAP SLIP PAD LH

Section 1: FITTING TORSION BAR COMPONENTS



1.1 Open the tailgate. Remove and discard the rubber bung (if fitted) on the body of the tub near the RH Hinge.

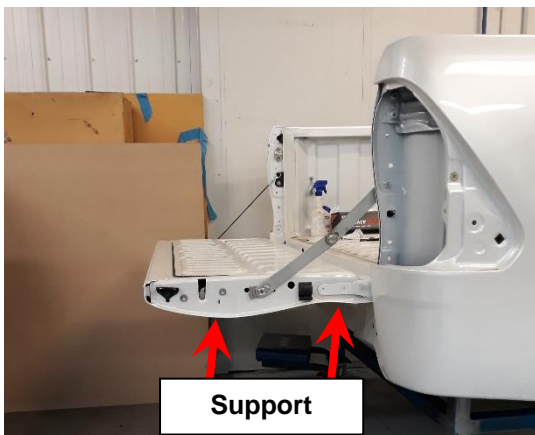

1.2 Support the tailgate in the open position to avoid any chance of the tailgate falling as hinge bolts are to be removed as part of installing the Tailgate Lift Assembly.

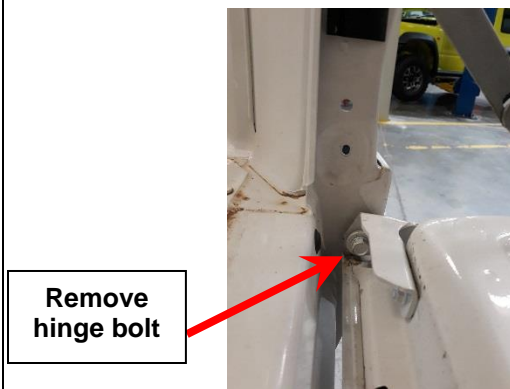

1.3 Remove the hinge bolt from the RHS of the tailgate and discard.

Clean the threaded hole with WD40 or similar.

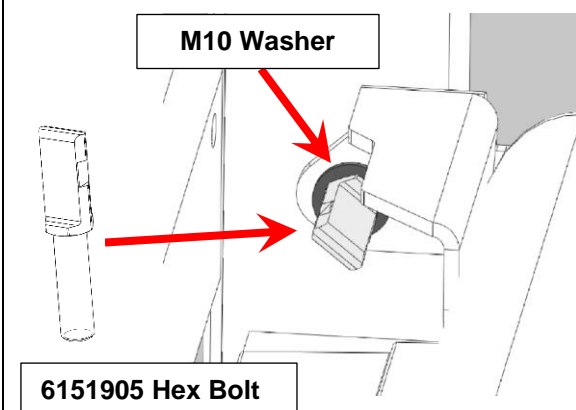

1.4 Replace the hinge bolt with the 6151905 Hex Bolt and M10 Washer. Tighten the Bolt whilst allowing the tailgate to rotate easily by hand and orient it as shown. If necessary, slightly loosen the Bolt by turning it anticlockwise to achieve this position.

At this point the support holding the tailgate up may be removed.

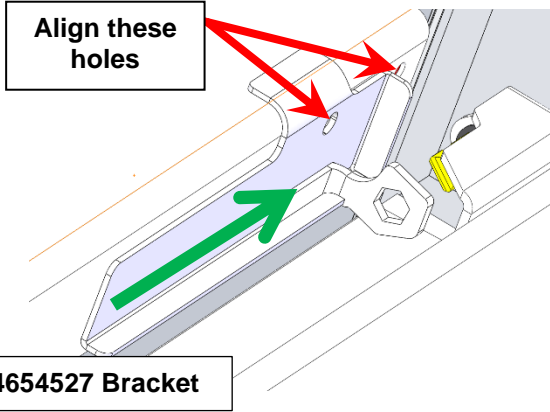
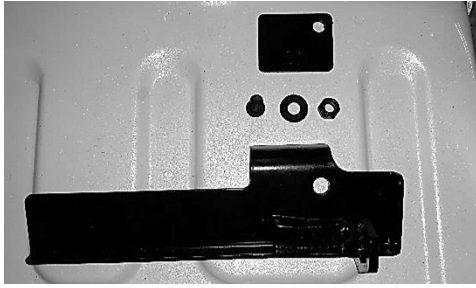

4654527 Bracket

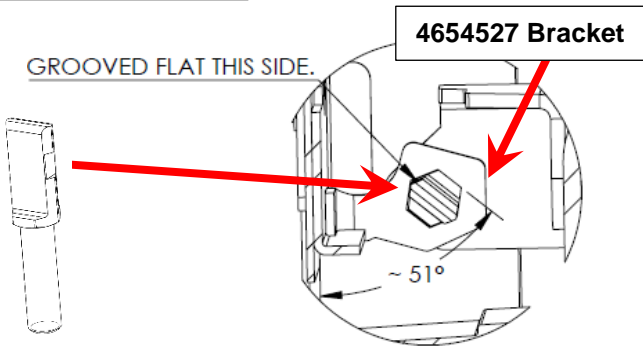

- 1.5 Place the 4654527 Bracket onto the tub so the rear of the bracket butts up against the tub while the return fold with large radius is against the tub floor. Slide the bracket so the hexagonal hole of the Bracket slides over the Hex Bolt in the orientation as shown.
- 1.6 Slide the bracket along so the hole in the tub aligns with the hole in the bracket.

It is important to maintain the orientation of the bolt.

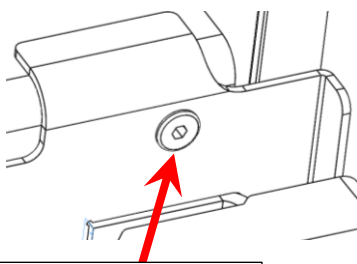

6151882 M8 Ultra Thin Head Screw



Assembly as viewed from underside of Tub

- 1.7 Affix the Bracket to the tub using the 6151882 M8 Ultra Thin Head Screw through the aligned holes from the tailgate side. From the underside of the tub, use the 3195116 Back Plate, M8 Washer and Nyloc as shown.

Do not fully tighten the screw & nut at this stage.



- 1.8 Remove the Tailgate Inspection Panel to enable access to the inside of the tailgate. (Retain all parts to refit at a later stage.)



Cover over sharp edges to prevent injury



Locate the centre hole on the tailgate

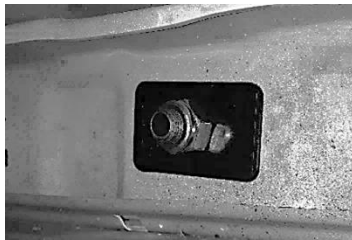

Back Plate and Nut as viewed from inside the tailgate

- 1.9 Locate the lower centre hole of the tailgate. From the outside, insert the 6365071 Threaded Bush through 3750386 Bracket and the tailgate hole and position the Bracket.
- 1.10 From inside the tailgate, (through the inspection panel opening), locate the previously inserted threaded bush and align the 3195138 Back Plate and M12 Nyloc nut into position and **tighten to 10Nm**

DO NOT reattach the inspection panel at this stage.

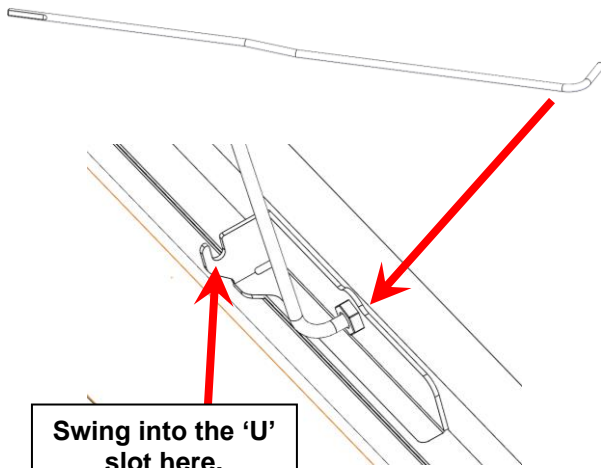

Swing into the 'U' slot here.

- 1.11 Taking the bent end of the Torsion Spring, feed it into the Threaded Bush and swing it into the 'U' slot of the Bracket.

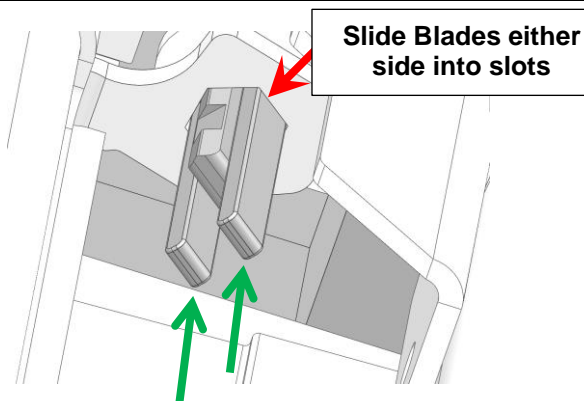

Slide Blades either side into slots

- 1.12 Slide in the 3193801 support blades through the hex bracket above the large flat surfaces of the Hex Bolt. (Blades should hold in position)

Smaller bore
This end

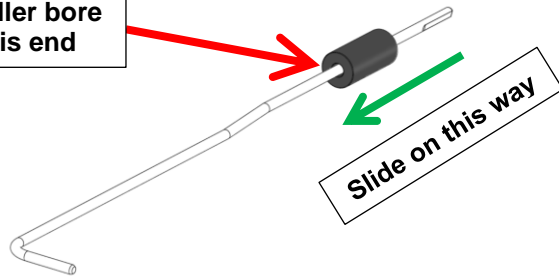

- 1.13 At the free end of the Torsion Spring, place the sleeve over the Spring. (Insert the sleeve through the smaller bore into the Torsion Spring.)



Tailgate opened
approx. 30°

- 1.14 Swing the tailgate to approximately 30° from the closed position and support (Ajar position)

- 1.15 Hold the Blades in position and from below the tailgate, slide the flat section of the torsion spring in between blades. (you may need to adjust the tailgate position to ensure clean alignment.)

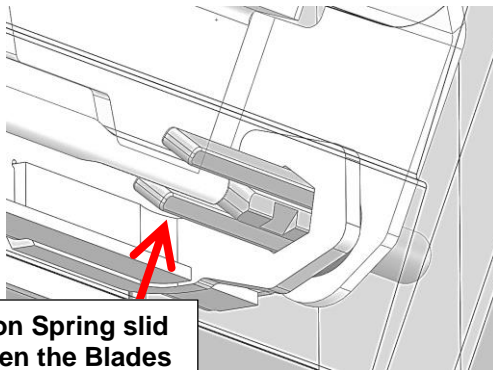

Torsion Spring slid
between the Blades

- 1.16 Once the torsion spring is in position (and the tailgate remaining ajar) slide the Sleeve over the Blades and Hex Stud, the Sleeve should go very close to the Hex Bracket.

Note: If there is misalignment, the Sleeve bush will not slide in fully, and there will be a big gap between bracket and the Sleeve Bush.

If the Bush is to be rotated or adjusted, return the tailgate to the ajar position prior to rotating if it is difficult to move.



If for any reason the tailgate needs to be lowered, ensure the bush is either fully slid on or completely removed and torsion spring is slid out. Having half engaged torsion spring and Blades can result in serious damage.

Grub Screw aligned to Hex Stud and Below surface of Sleeve

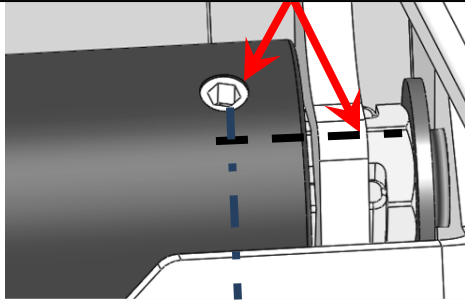

Grub Screw top surface **MUST** be below bush surface.

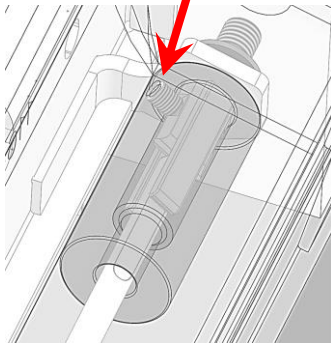
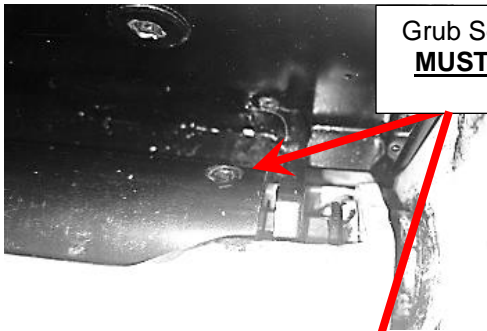

1.17 Open the Tailgate to access the Sleeve

1.18 Align the Grub Screw hole to the upper ridge on the Hex Stud and screw the Grub Screw down to **6Nm** onto the machined flat slot of the Hex Stud. Check that the Grub Screw top surface is below the Sleeve outer surface when tightened. If it is not, slightly rotate bush and re-tighten so the Grub Screw's top surface is below the Sleeve surface. Ensure the Sleeve is secured by trying to move or rotate it. When the Grub Screw is properly positioned and tightened fully to 6Nm the Sleeve will not move in any direction.



If the Grub Screw is not tightened correctly into the groove, the Sleeve may become loose and allow it to slide off the Hex Stud and dislodge the Torsion Spring. Damage or injury may result if not correctly tightened.

If the top of the Grub Screw sits above the surface of the Sleeve, it indicates the Grub Screw is not positioned correctly. Loosen the screw slightly and with the tailgate held ajar, rotate the Sleeve slightly so the Grub Screw and Hexagonal ridge are aligned. Repeat tightening procedure.

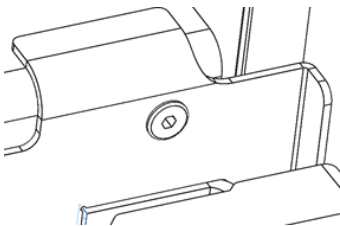

1.19 Tail gate in lowered position: Tighten the 6151882 M8 Ultra Thin Head Screw & M8 Nyloc nut which was left loose on step 1.7. Torque to 10Nm.



**DO NOT OVERTORQUE,
OVER TORQUING MAY RESULT IN
DISTORTION/FAILURE OF THE
COMPONENTS!**



Section 2: FITTING CABLE RETAINING STRAPS (RH)



- 2.1 Undo the 2 screws (1 screw on the body & 1 on the tailgate) holding the limiting strap on RH side.
- 2.2 Remove the straps, washer & strap guide bracket (on the tailgate) and discard all items.
- 2.3 Clean the holes with WD40 or similar.
- 2.4 Remove plastic buffers on the body and on the tailgate and discard.

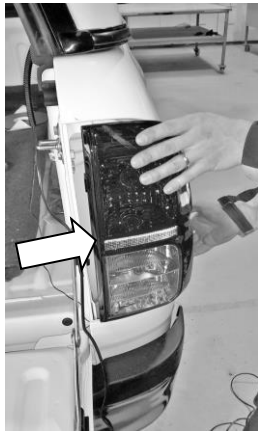
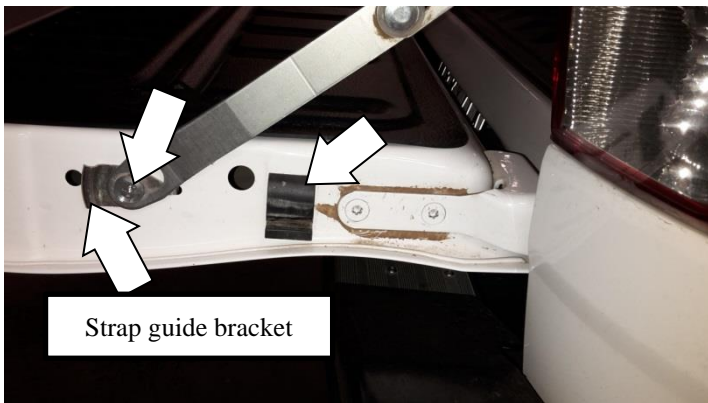

- 2.5 Undo the 2 screws holding the rear tail lamp assembly to the rear of the tub on the right-hand side.
- 2.6 Pull the light outwards to the side of the vehicle and disengage it from the tub.
- 2.7 Remove the Original Strap and all strap hardware whilst retaining only the original M8 Bolts

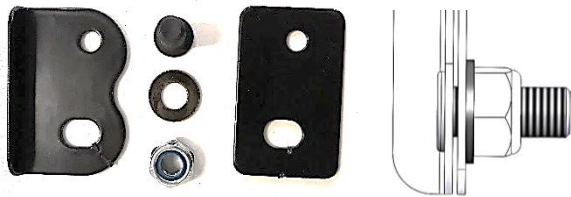

- 2.1 Locate the 3750441R Upper Mount Bracket and fasten with 6152031 M10 Ultra Thin Head Screw, Washer and Nyloc as shown. Torque M10 Ultra thin head screw to **12Nm**.
- 2.2 Using the remaining hole in the Upper Mount Bracket as a guide, drill through it an 8mm diameter hole and de-burr the hole in the side panel of the tub. Paint the drilled hole with suitable primer paint to prevent rust.

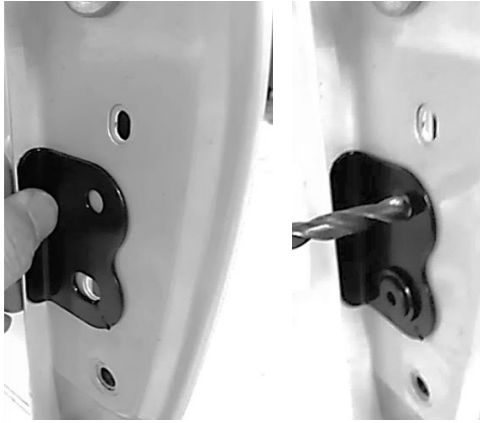

2.8 Remove the Bracket and reassemble using the 3195150 Plate on the inside of the Tail Light cavity to sandwich the panel.

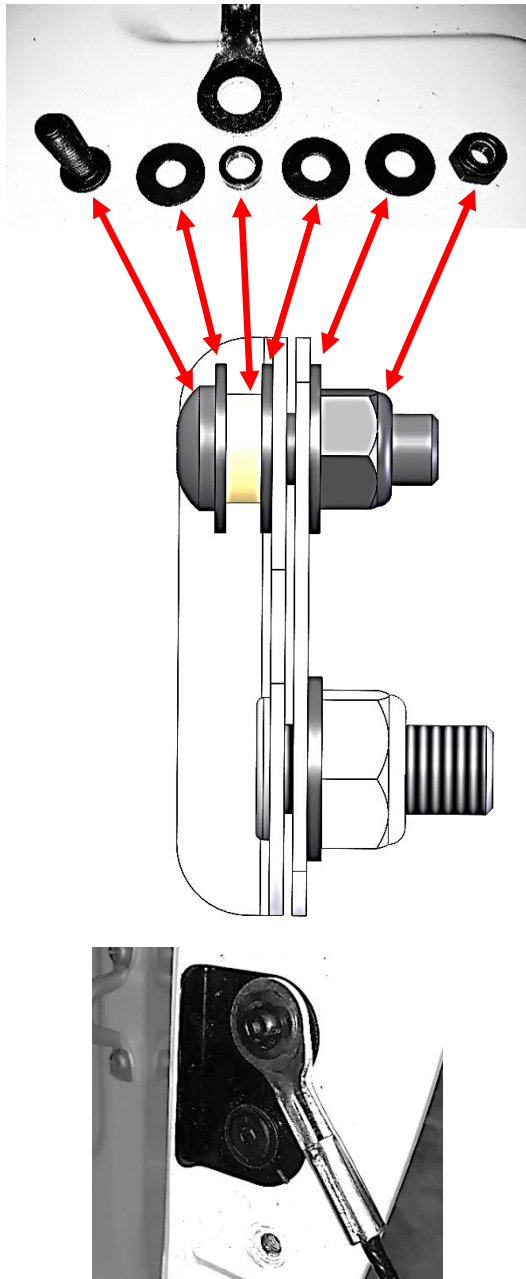

2.3 Fasten the eye end of the 6821348 Cable through this hole as shown using an 6151464 M8 Button Head Screw, 3x M8 Washers, 5848468 Spacer and Nyloc Nut.

Tighten M8 button head screw to 22Nm
Torque M10 Ultra thin head screw to 12Nm.

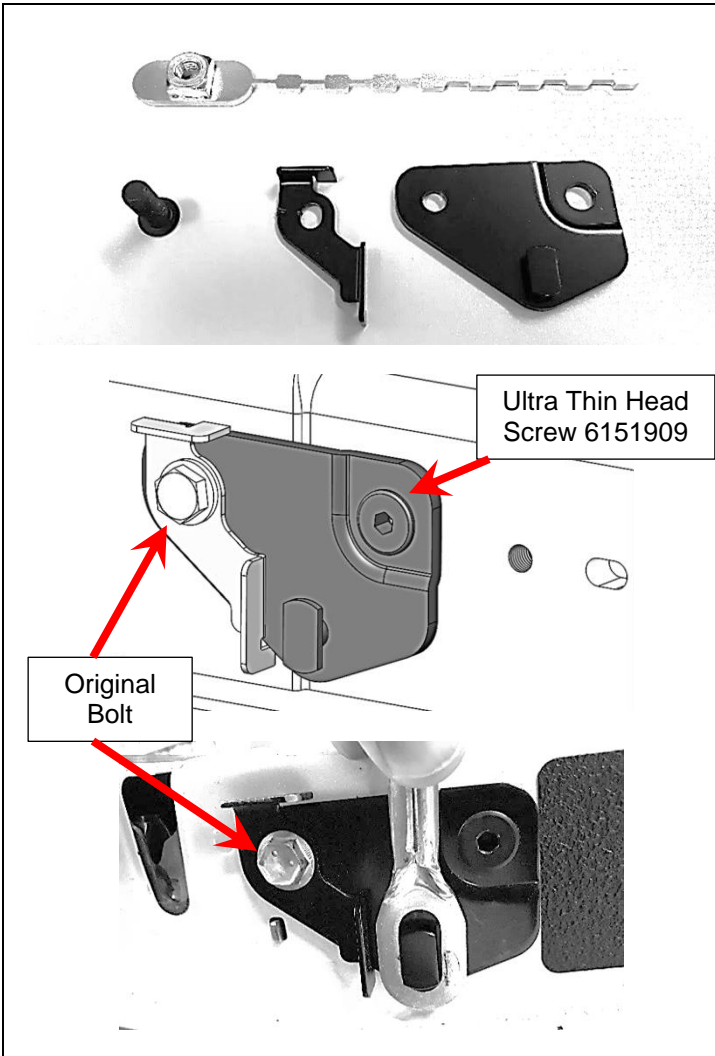

- 2.4 Using an 6151909 M8 Ultra Thin Head Screw, affix the 3750443R Lower Cable Mount and 3750444R Cable Keeper to the tailgate as shown, so the remaining hole is aligned to its mating hole in the tailgate. Using the 3759081 Nut Plate on the inside of the tailgate, tighten the 6151909 M8 Ultra Thin Head Screw to **10Nm**.
- 2.5 Using the original M8 Bolt previously removed, locate the 3750444R onto the Lower Cable Mount and Tighten to **22Nm**.
- 2.6 The slotted end of the cable may now be attached.

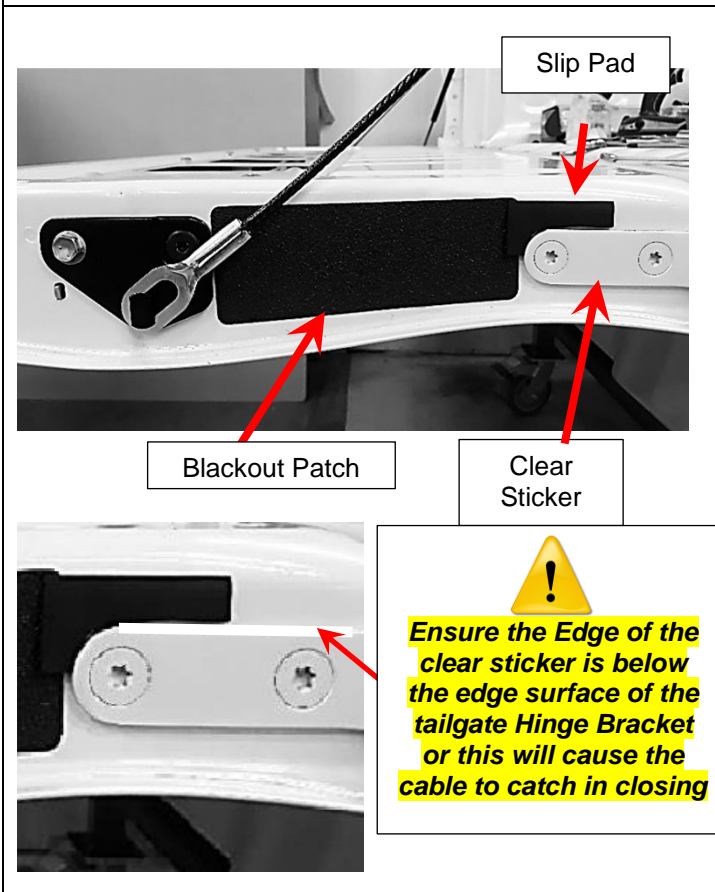

- 2.7 Using an alcohol wipe, clean all areas along the side of tailgate where the 2125739R Blackout Patch, 2125755R Slip Pad and 2125725 Clear Sticker are to be used. Clean for both sides of the tailgate
 - 2.8 Attach the Slip Pad first and then the blackout Sticker in position as shown, making sure to cover all holes and keep even to the line of tailgate
- These items are necessary to protect surfaces and allow the cable to ride over the tailgate hinge without damaging the cable or mating parts.**

THE RIGHT HAND SIDE IS NOW COMPLETE AND RH TAIL LIGHT MAY NOW BE REFITTED INTO POSITION

If you have any queries regarding the installation of this product please contact the distributor from whom it was purchased, or alternatively the ARB office in your state.
 Head Office – ARB Corporation Ltd VIC: 42-44 Garden Street, Kilsyth, Victoria, 3137 Tel: (03) 9761 6622 Fax: (03) 9761 6807
 WA:(08) 9244 3553 NSW: (02) 9821 3633 ACT: (02) 6280 7475 SA: (08) 8244 5001 QLD: (07) 3872 3872 NT: (08) 8947 2262 TAS: (03) 6331 4190

Section 3: CABLE RETAINING STRAPS (LH)

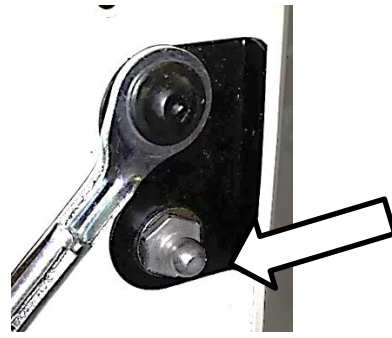
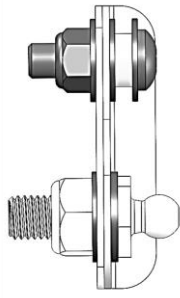

- 3.1 Fitting the LH Cable Retaining Strap is a repeat of the instruction for RH in Section 2

The only difference to RH is using the 6152030 Ball Stud in place of the 6152031 Ultra Thin Head Screw as shown.

The tailgate inspection panel may now be refitted into position.

Section 4: FITTING DAMPENING STRUT ON LH SIDE

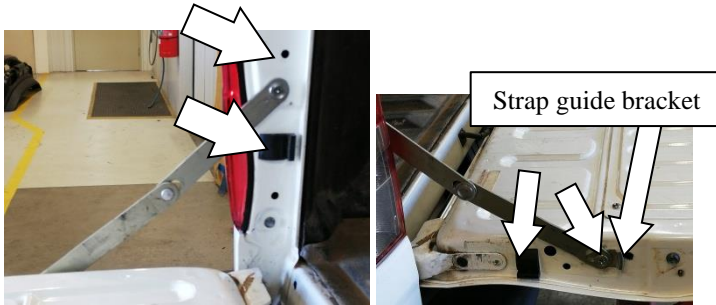

- 4.1 Ensure RH side strap is holding the tailgate and similar to RH side follow steps, 2.1 to 2.4 to remove the OEM straps on LH side.



- 4.2 On the tailgate, remove the countersunk hinge screw nearest where the tailgate mounts to the vehicle and replace with the 6151908 Countersunk Ball Stud.

Tighten the Ball Stud **to 22Nm**

- 4.3 Attach the blackout (2125739L) and clear Stickers (2125725), making sure to cover all holes and keep even to the line of tailgate

! Ensure the Edge of the clear sticker is below the edge surface of the tailgate Hinge Bracket or this will cause the cable to catch in closing

! Extending the clear sticker edge beyond the Hinge bracket upper surface can lead to damaging the Limit strap & the Dampener.





- 4.4 Fit the 4590031 Damper with the Rod end of the Damper clipped to the ball stud fitted to the tailgate.
- 4.5 Fit the cylinder end of the Damper into the to the ball stud on the LH side of the vehicle tub.
- 4.6 Operate the tailgate 5 times to make sure the action is opening and closing easily.



Check the cable strap is sitting under the lower end of the Damper and to the tailgate side when the tailgate is closed

**THE LEFT HAND SIDE IS NOW COMPLETE AND
LH TAIL LIGHT MAY NOW BE REFITTED INTO
POSITION**